

**LEGO** DIGITAL DESIGNER 4.2

Model Name:  
**TGA**

Number of Bricks: **51**

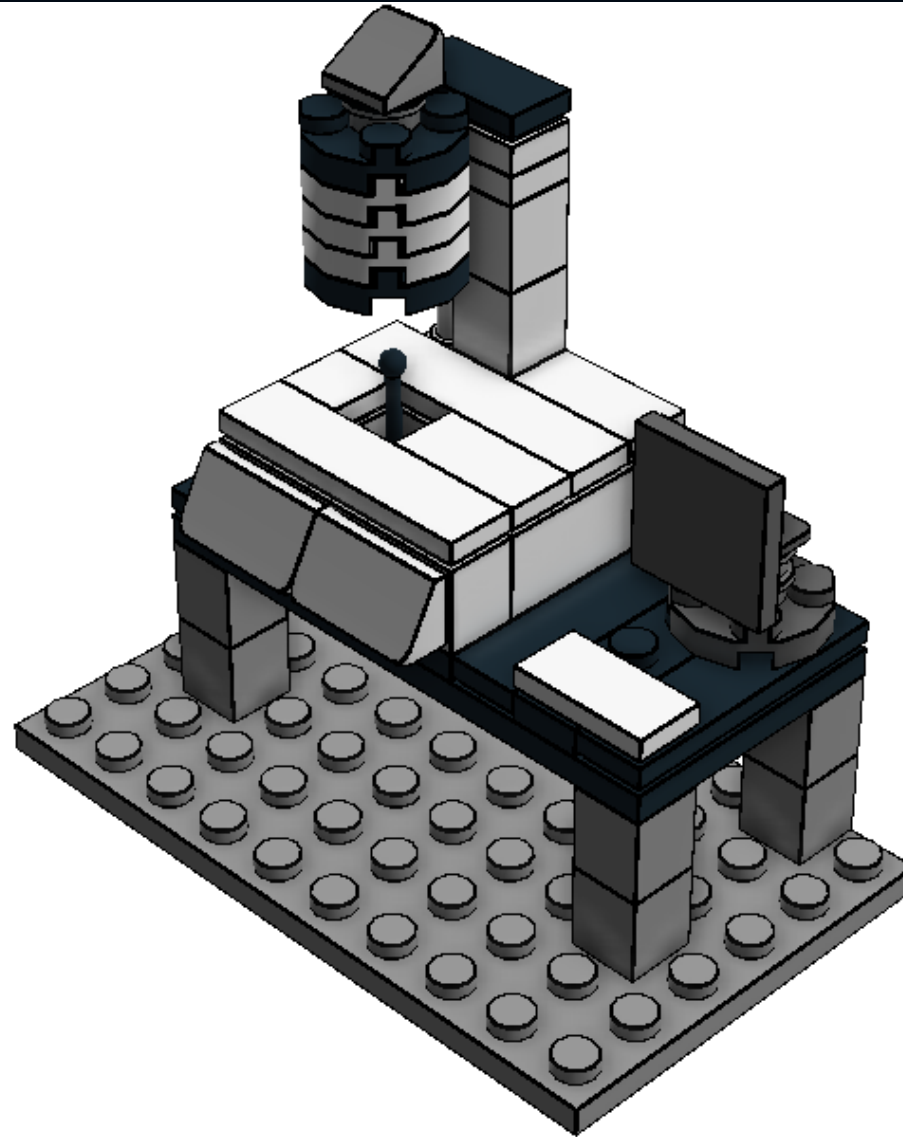

**Step 1 of 22**

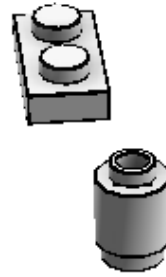
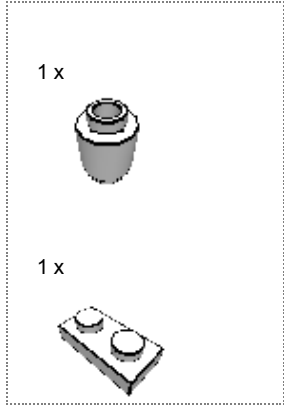

**Step 2 of 22**

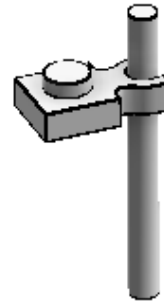
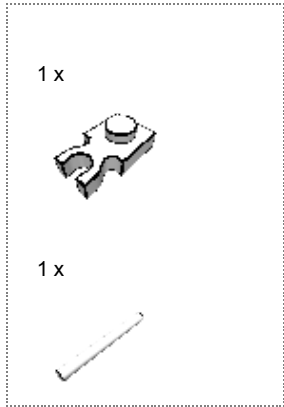

**Step 3 of 22**



**Step 4 of 22**

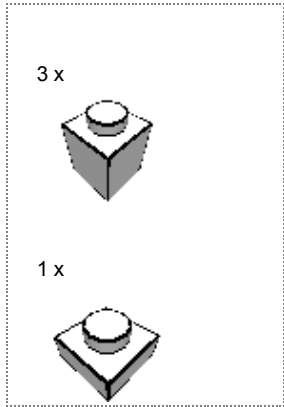

**Step 5 of 22**

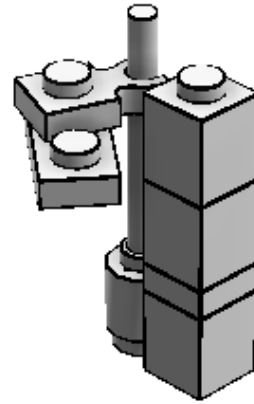

Step 6 of 22

1 x



1 x

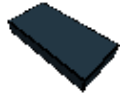

1 x

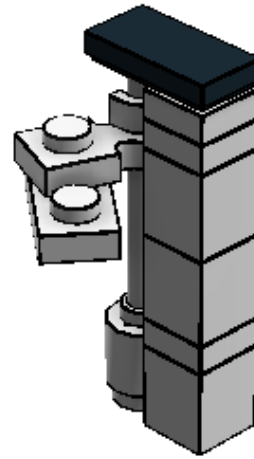

**Step 7 of 22**

1 x



2 x





Step 8 of 22

1 x



1 x



1 x



1 x



**Step 9 of 22**

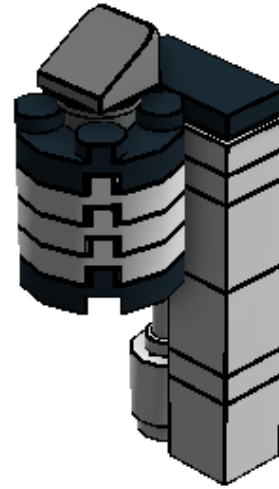

Step 10 of 22

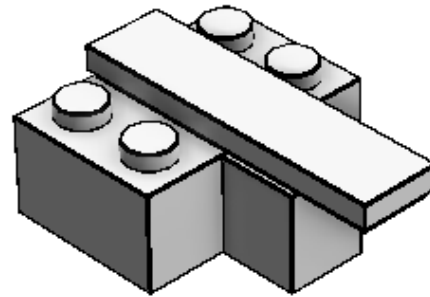
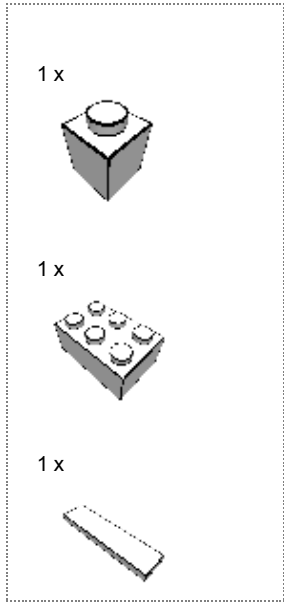

Step 11 of 22

1 x



1 x

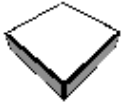

2 x

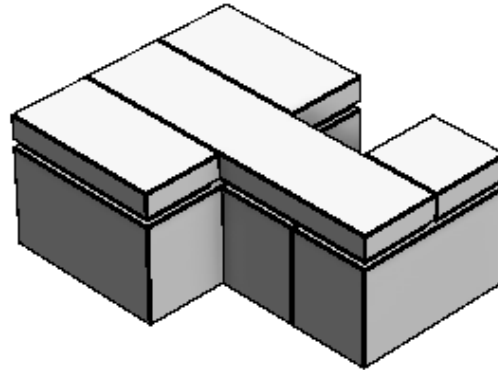

**Step 12 of 22**

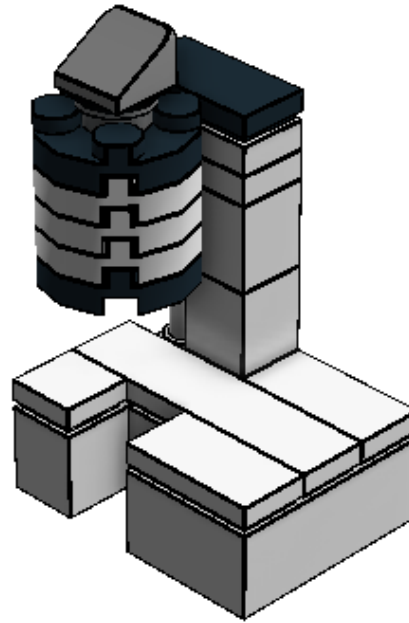

Step 13 of 22

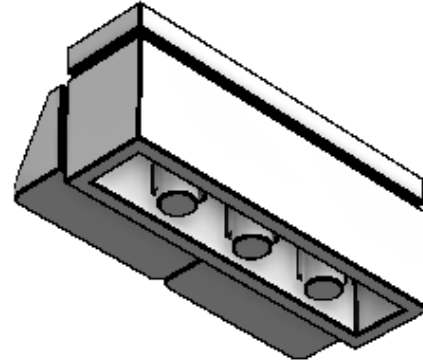
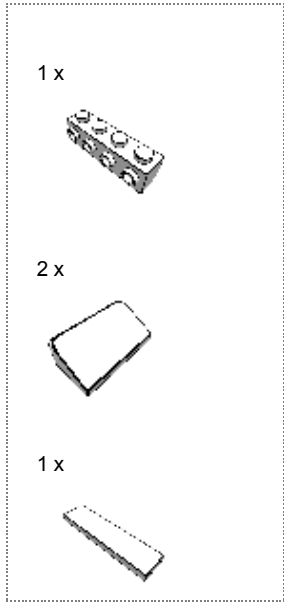



Step 15 of 22

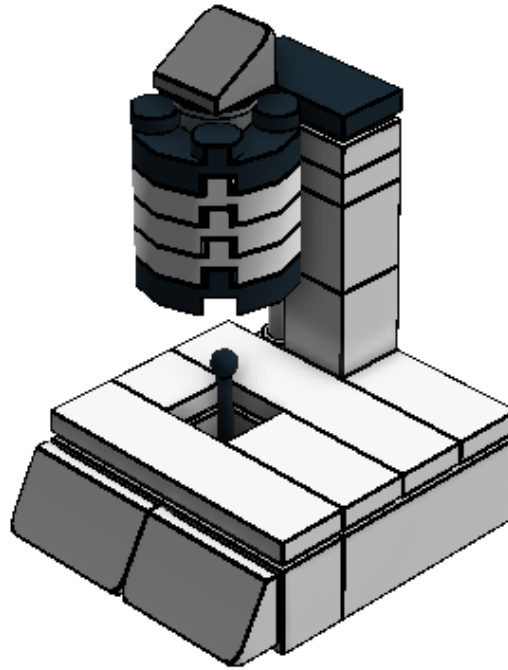



**Step 16 of 22**

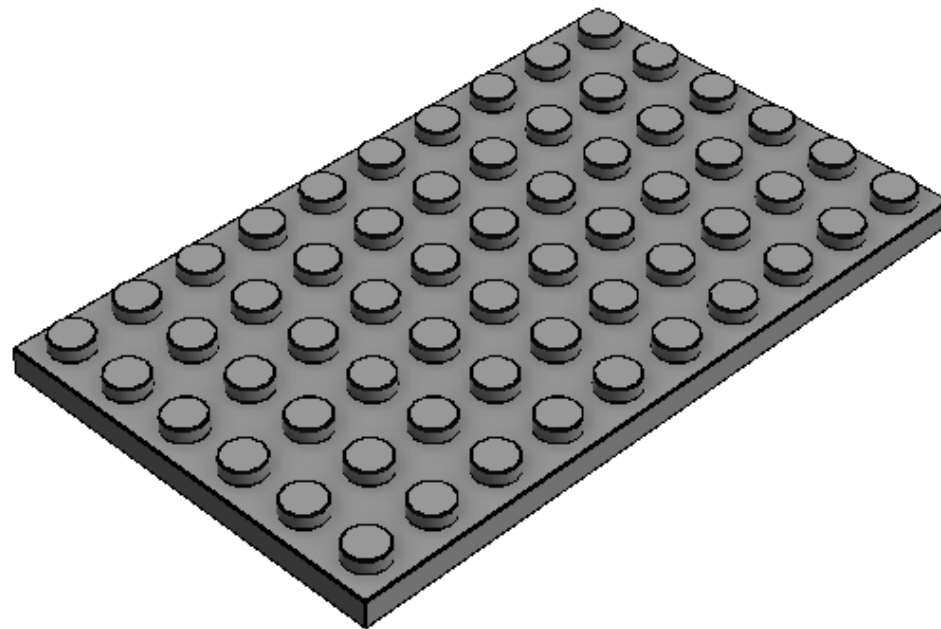
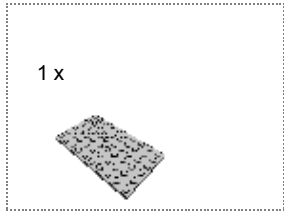

Step 17 of 22

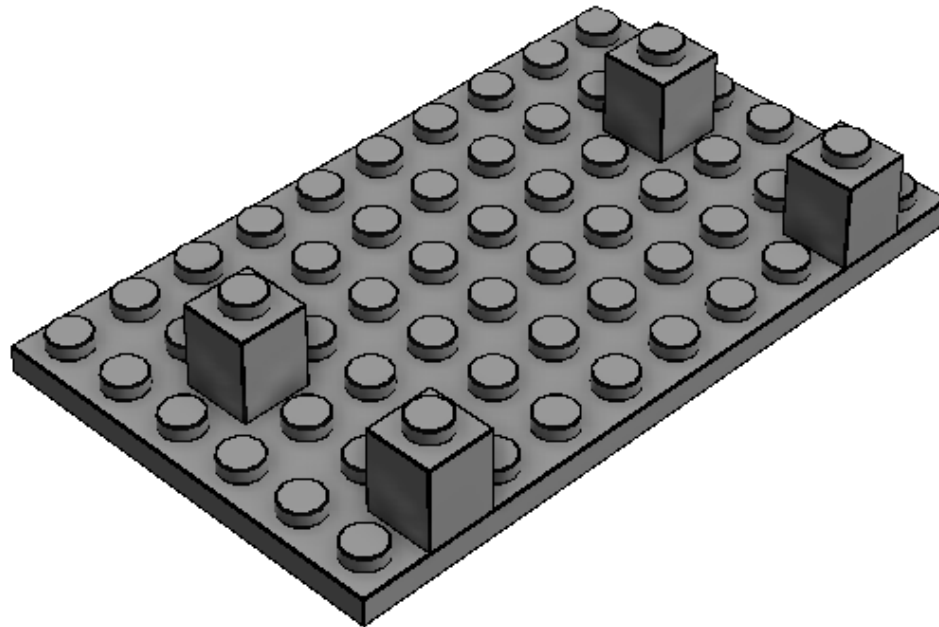
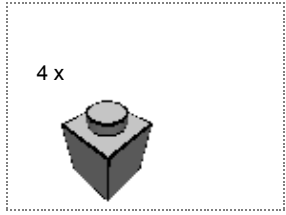

Step 18 of 22

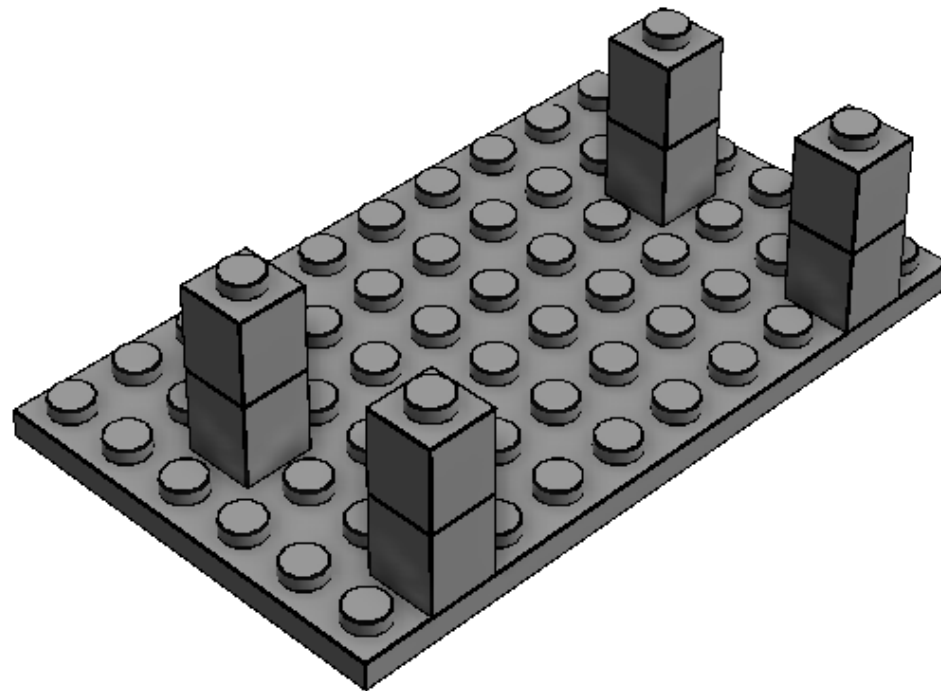
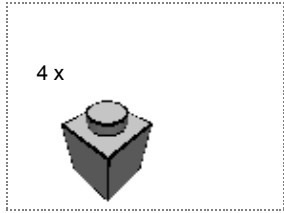

Step 19 of 22

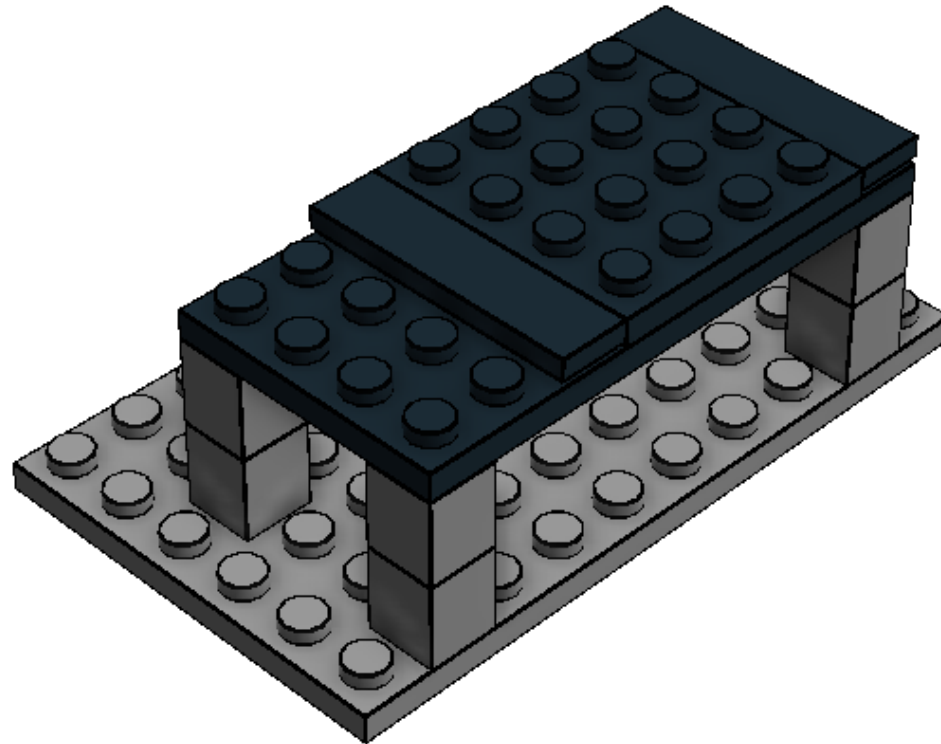
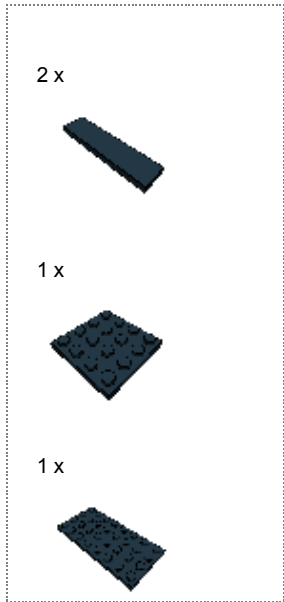

Step 20 of 22

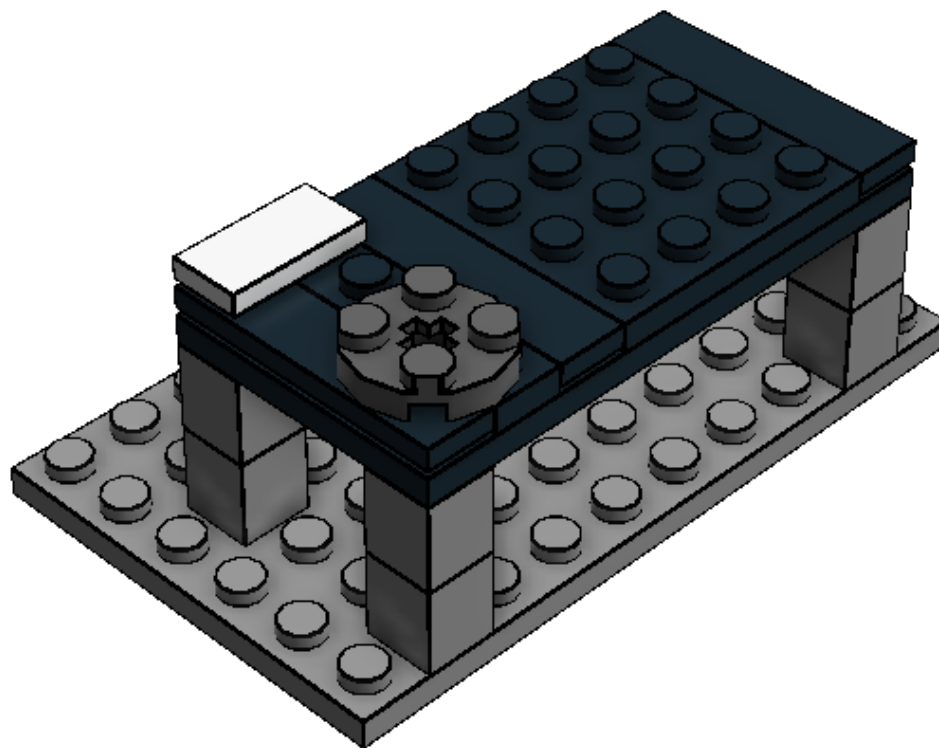
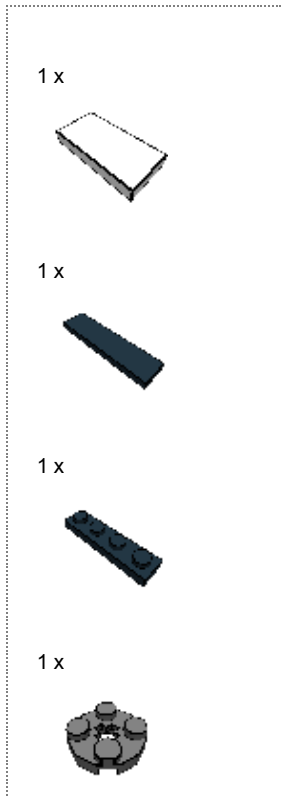

Step 21 of 22

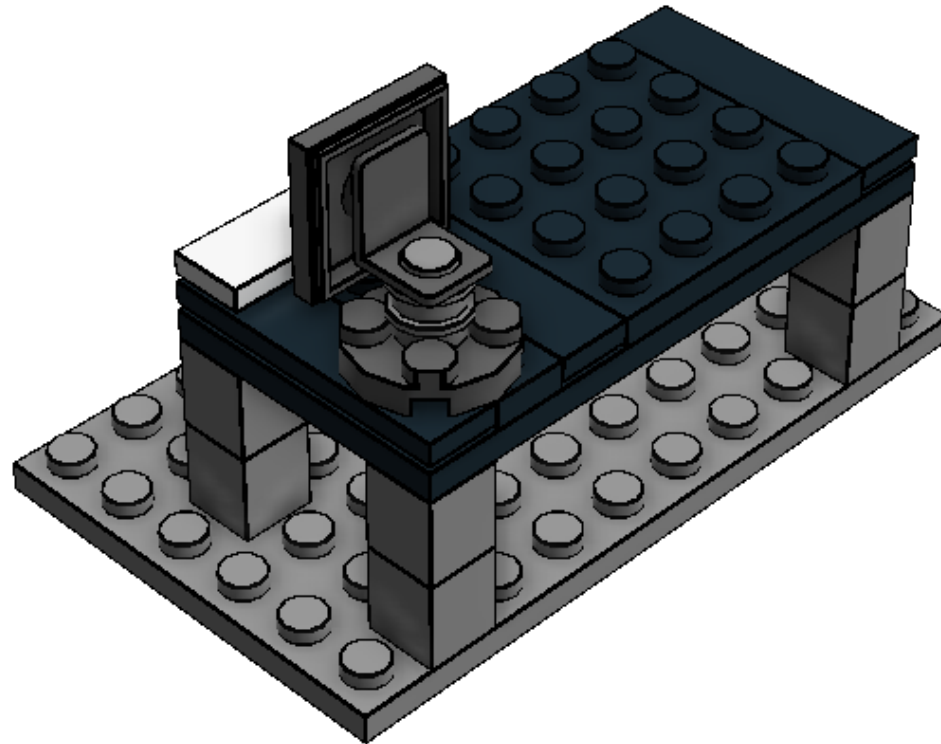
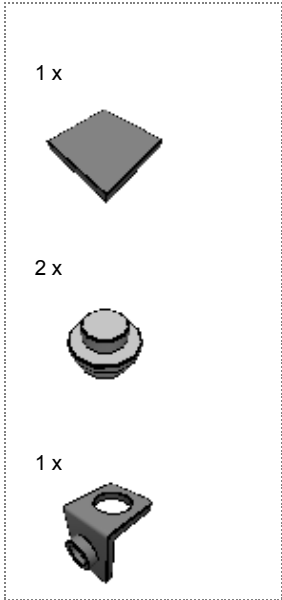



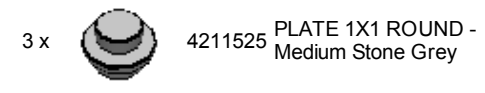
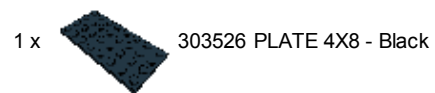
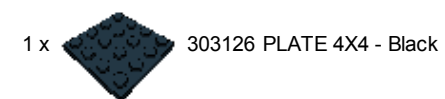
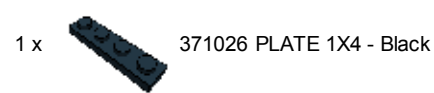
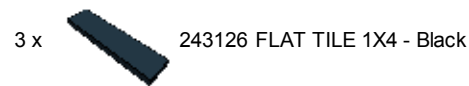
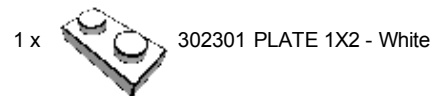
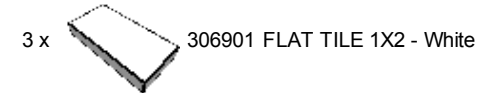
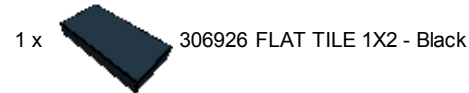
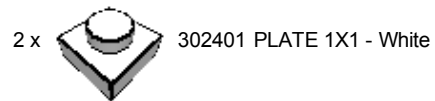
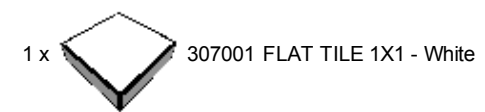
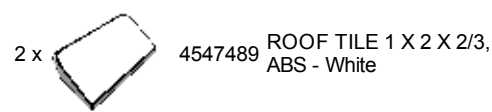
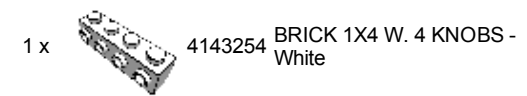
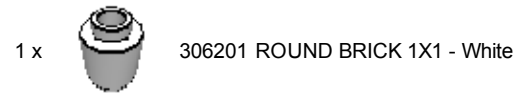
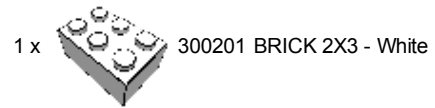
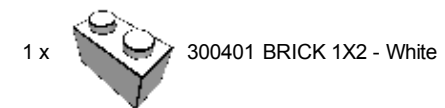
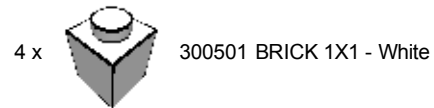
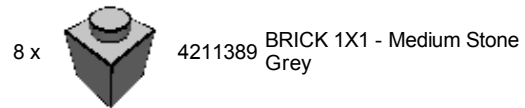





2 x  403226 PLATE 2X2 ROUND - Black

1 x  4211042 PLATE 2X2 ROUND - Dark Stone Grey

3 x  403201 PLATE 2X2 ROUND - White

2 x  4517923 PLATE 1X1 W. HOLDER - White

1 x  4129836 LIGHT SWORD - BLADE - White

1 x  73587 MINI ANTENNA - Black

1 x  4210469 MINI FIG. BACK PLATE W. KNOB - Dark Stone Grey

© 2012 The LEGO Group. All rights reserved.  
Use of the LEGO Digital Designer html print tool, signifies your agreement to the terms of use.